

CORRSHOP

DISPLAY ASSEMBLY

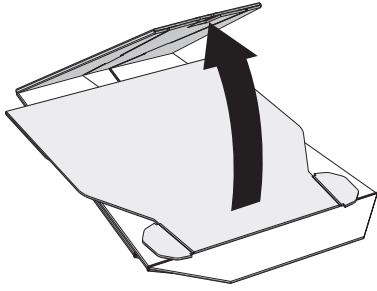

1. Unfold base.

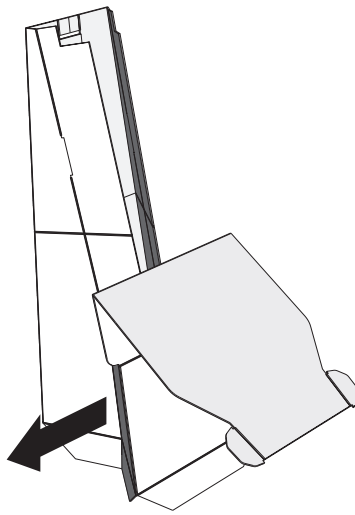

2. Square up base by pulling sides out.

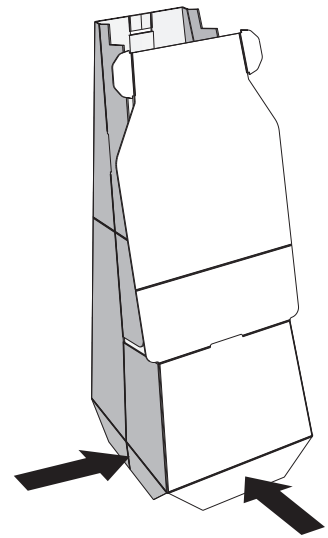

3. Fold bottom flaps underneath base. This will keep base open and square.

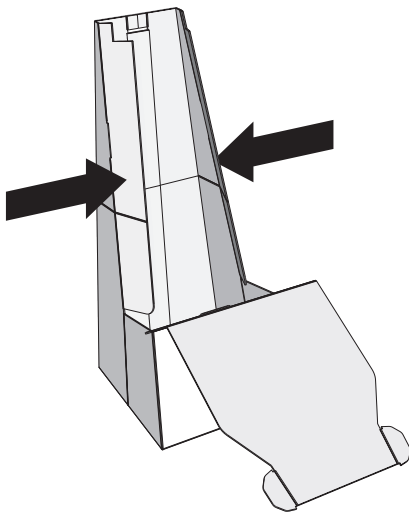

4. Fold in side flaps.

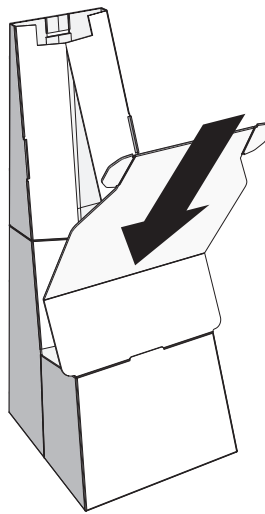

5. Fold center flap down as shown above to form the tray support.

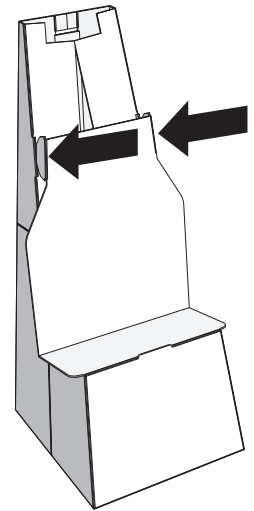

6. Push tabs near top of center flap through slots on sides of base.

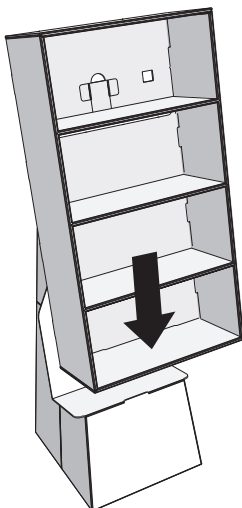

7. Place tray onto base. Small hole on bottom of tray should line up with tab at front edge of base.

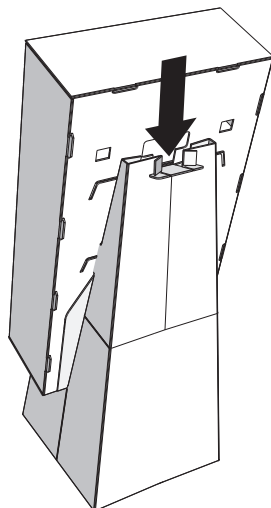

8. Fold T shaped tab on back of tray down through opening on back of base.

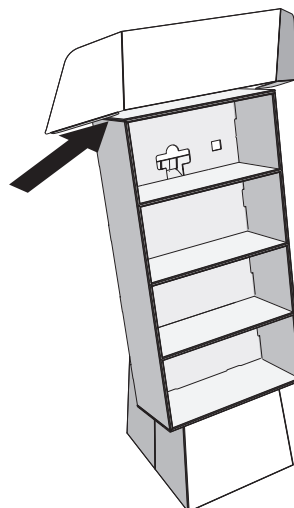

9. Attach header card by sliding bottom side flaps into space at top edges of tray.

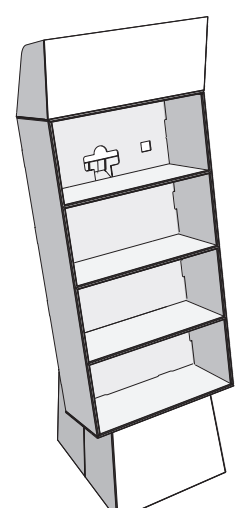

10. Assembly complete!